

电力电子电容器

Capacitors for power electronics

一、电容器选用指南 Guide for capacitors choosing

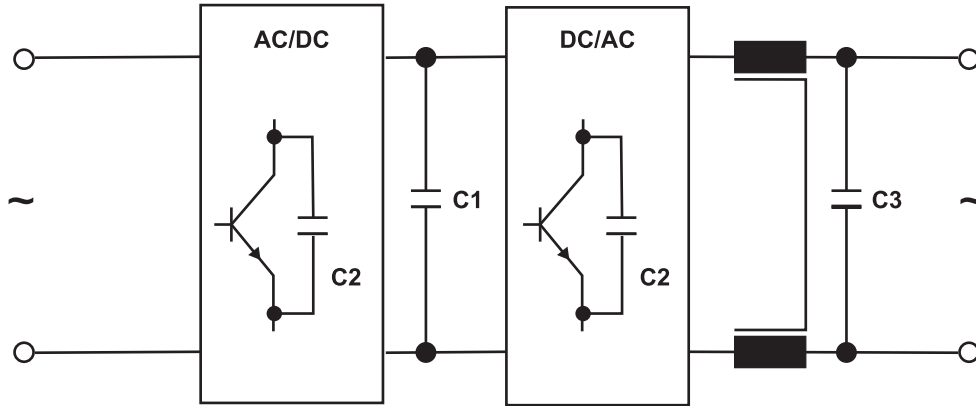

序号 No.	功能 Function	PCB安装系列 For PCB mounting series	螺纹式、焊片式引出系列 Screw, lug terminals series
C1	直流滤波 DC Link	C3D	C3A, C3A(G), C3B, C3E, C36, C3N
C2	IGBT吸收 IGBT Snubber	C3H, C16, C82, C32 (Please refer to the PCB Catalogue for C82 & C32)	C38
C3	交流滤波 AC filter	C6A	C66, C69 (单相Single phase) C65(A), C67 (三相Three phases)

其它系列 Other series

C3G: 插片式引出, 用于高压交流吸收滤波, 如dV/dt滤波器

Fast-on terminals, for high AC voltage snubber application, such as dV/dt filter

C3K: 螺孔式引出, 用于GTO缓冲/吸收保护

Thread hole terminals, damper/snubber for GTO protection



二、电力电子电容器的标准体系

电力电子电容器的主要标准是由中国国家标准委员会发布的GB/T17702.1、GB/T17702.2和GB/T12747.1、GB/T12747.2(分别等同于由IEC 33技术委员会(电力电容器)制定IEC61071, IEC 60831-1、IEC60831-2)。

作为补充, 我司也引用了GB/T25121(等同于IEC61881)、GB/T21563(等同于IEC61373)和AEC-Q200等标准, 以满足铁路、汽车等特定场合的应用要求。

我司主要在上述标准的基础上制定了各个型号电力电子电容器的企业标准, 以供内部引用。

另外, 电力电子电容器的部分标准术语也参考了其它电容器标准中的定义, 不再一一列出。

以上, 构成了电力电子电容器的标准体系
 电力电子电容器的标准体系, 举例如下:

二、The standard system of capacitors for power electronics

The main standards are GB/T17702.1&GB/T17702.2 and GB/T12747.1&GB/T12747.2, published by China National standardizing committee. These standards are equal to IEC61071, IEC60831-1&IEC60831-2, prepared by IEC technical committee 33: Power capacitors

As supplementary, faratronic also refers to GB/T25121 (IEC61881 idt), GB/T21563 (IEC61373 idt) and AEC-Q200 and so on, for railway or automobile applications.

According to the basic requirements of above standards, Faratronic made detailed standards of various types of capacitors for internal use.

In additional, some terminologies are also reference to other capacitor standards, which will be not listed below.

The standard system of lamp capacitors is made up of all above standards.

Following, please find the corresponding specification lists for power electronics capacitors.

标准号 (No.)	标准 (Standards)
GB/T 17702.1 (IEC 61071)	电力电子电容器 第1部分: 总则 Capacitors for power electronics Part 1: General
GB/T 17702.2 (IEC 61071)	电力电子电容器 第2部分: 熔丝的隔离试验、破坏试验、自愈性试验及耐久性试验的要求 Capacitors for power electronics Part 2: Requirements for disconnecting test on fuses, destruction test, self-healing test and endurance test
GB/T 12747-1 (IEC 60831-1)	标称电压1KV及以下交流电力系统用自愈式并联电容器 第1部分: 总则—性能、试验和定额—安全要求—安装和运行导则 Shunt power capacitors of the self-healing type for a.c. systems having a rated voltage up to and including 1 000V Part 1: General - Performance, testing and rating - Safety requirements - Guide for installation and operation
GB/T 12747-2 (IEC 60831-2)	标称电压1KV及以下交流电力系统用自愈式并联电容器 第2部分: 老化试验、自愈性试验和破坏试验 Shunt power capacitors of the self-healing type for a.c. systems having a rated voltage up to and including 1 000V Part 1: Ageing test, self-healing test and destruction test
GB/T 25121 (IEC 61881)	轨道交通 机车车辆设备 电力电子电容器 Railway applications - Rolling stock equipment - Capacitors for power electronics
GB/T 21563 (IEC 61373)	轨道交通 机车车辆设备 冲击和振动试验 Railway applications - Rolling stock equipment Shock and vibration tests
GB/T 2693 (IEC 60384-1)	电子设备用固定电容器 第1部分: 总规范 Fixed capacitors for use in electronic equipment Part 1: Generic specification
AEC-Q200	STRESS TEST QUALIFICATION FOR PASSIVE COMPONENTS
GB/T 4798-1 (IEC 60721-3-1)	电工电子产品应用环境条件 第1部分 贮存 Classification of environmental conditions Part 3 Classification of groups of environmental parameters and their severities Section 1 Storage
GB/T 4798-2 (IEC 60721-3-2)	电工电子产品应用环境条件 第2部分 运输 Classification of environmental conditions Part 3 Classification of groups of environmental parameters and their severities Section 2 Transportation
GB/T 4798-3 (IEC 60721-3-3)	电工电子产品应用环境条件 第3部分 有气候防护场所固定使用 Classification of environmental conditions Part 3 Classification of groups of environmental parameters and their severities Section 3 Stationary use at weatherprotected locations
	详细规范: Detail specification for C16, C36, C38, C3A, C3B, C3D, C3E, C3G, C3H, C3K, C3N, C65(A), C66, C67, C69, C6A

三、常用的标准术语

1、额定容量 C_N

电容器在 $20^{\circ}\text{C}/50\text{Hz}$ 下的设计电容量。

2、额定电压 U_N

对采用IEC 60831-1/-2标准的电容器，仅指设计电容器时规定的交流电压方均根值。

对采用IEC 61071标准的电容器，可分为：

额定交流电压 U_{NAC} ：设计电容器时所采用的反复型波形的任一极性的最高运行峰值周期电压。

额定直流电压 U_{NDC} ：设计电容器时所采用的非反复型波形的任一极性的可连续运行的最高运行峰值电压。其值应大于直流工作电压与纹波电压峰值之和。

若仅采用交流额定电压或直流额定电压，可直接用 U_N 来表示；若同时采用这两种额定电压，需用 U_{NAC} 与 U_{NDC} 加以区分。

三、Terminologies

1.Rated capacitance C_N

Designed capacitance of the capacitor at $20^{\circ}\text{C}/50\text{Hz}$.

2.Rated voltage U_N

For the capacitor referenced to IEC 60831-1/-2, it only means the r.m.s. value of a.c. voltage for which the capacitor has been designed. For the capacitor referenced to IEC 61071, it is divided into, Rated a.c.voltage U_{NAC} : maximum operating peak recurrent voltage of either polarity of a reversing type waveform for which the capacitor has been designed.

Rated d.c.voltage U_{NDC} : maximum operating peak voltage of either polarity but of a non-reversing type waveform, for which the capacitor has been designed, for continuous operation.It shall be higher than the sum of operating d.c. voltage and operating ripple peak voltage. If just use rated a.c.voltage or rated d.c.voltage, U_N is useable. But if use both rated voltages, we should use both U_{NAC} and U_{NDC} to divide them.

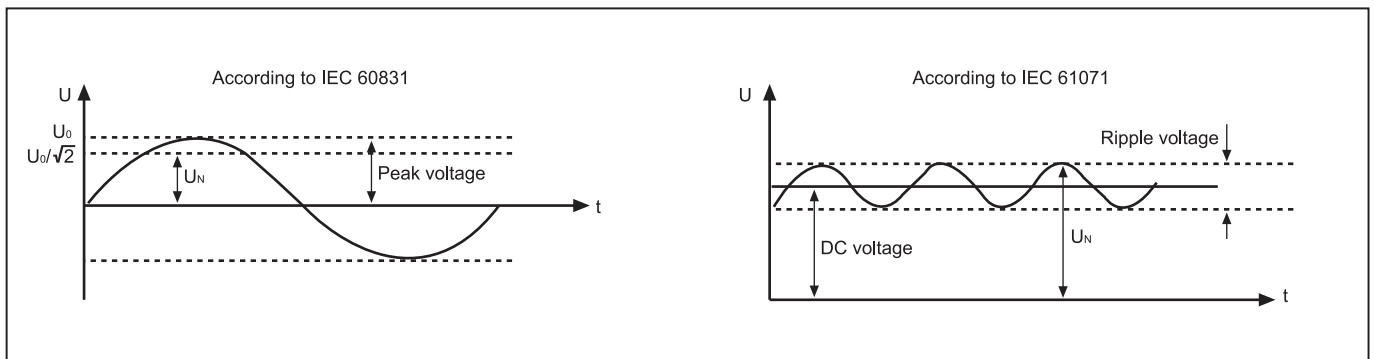

3、有效值电压 U_{rms}

电容器在连续运行过程中允许出现的最大正弦交流电压的方均根值。

4、纹波电压 U_r

单向电压的峰到峰的交流分量。

5、非周期冲击电压 U_s

由切换或系统中任何别的扰动所导致的峰值电压，此电压只允许出现有限的次数，且每次持续时间应比基本周期短。

6、绝缘电压 U_i

设计电容器时规定的电容器端子对外壳或对地交流电压的方均根值。若未作说明，此绝缘电压等于额定电压除以 $\sqrt{2}$ 。

7、最大电流 I_{max}

连续运行时的最大电流的方均根值。

3.rms voltage U_{rms}

Root mean square of max. permissible value of sinusoidal a.c. voltage in continuous operation.

4.Ripple voltage U_r

Peak-to-peak alternating component of the unidirectional voltage.

5.Non-recurrent surge voltage U_s

Peak voltage induced by a switching or any other disturbance of the system which is allowed for a limited number of times and for durations shorter than the basic period.

6.Insulation voltage U_i

rms value of a.c.voltage designed for the insulation between terminals of the capacitor to case or earth.The insulation voltage is equal to the rated voltage of the capacitor, divided by $\sqrt{2}$, unless otherwise specified.

7.Maximum current I_{max}

Maximum rms current for continuous operation.

8、最大峰值电流 \hat{I}

在连续运行中允许重复出现的最大峰值电流。其数值为:

$$\hat{I} = C_N \times (dV/dt)$$

其中 dV/dt 表示电压爬升速率, 即在运行中允许重复出现的最大电压爬升速率, 常用来代替 \hat{I} 使用。

9、最大冲击电流 \hat{I}_s

由切换或系统中任何别的扰动所导致的允许出现的峰值电流, 此电流只允许出现有限的次数, 且每次持续时间应比基本周期短。

10、串联电阻 R_s

在规定的运行条件下, 电容器的导体部分的等效内阻。串联电阻随温度升高而增大, 其电阻温度系数约为 $0.004/^\circ\text{C}$, 近似公式为:

$$R_s(T_2) = 1 + 0.004 \times (T_2 - T_1) \times R_s(T_1)$$

11、等效串联电阻 ESR

一个有效电阻, 当它和所探讨的电容器有相等电容值的理想电容器串联时, 在规定的运行条件下, 该电阻的损耗功率将等于该电容器中耗散的有功功率。

12、介质损耗因素 $\text{tg } \delta$

电容器的介质材料在额定频率下的损耗常数。聚丙烯薄膜的典型介质损耗因素为 2×10^{-4} 。

13、电容器的损耗因素 $\text{tg } \delta$

在规定频率的正弦波电压作用下, 电容器的损耗功率除以电容器的无功功率, 其值为等效串联电阻和容抗之比。

14、介质损耗功率 P_d

电容器的电介质由于极化或电导引起的损耗, 其值为:

$$P_d = \hat{U}^2 \times \pi \times f_0 \times C_N \times \text{tg } \delta$$

$$\text{直流电容器: } \hat{U} = U_r/2$$

$$\text{交流电容器: } \hat{U} = \sqrt{2} U_{\text{rms}}$$

$$\text{GTO吸收电容器: } \hat{U} = \sqrt{2} U_{\text{NDC}}/2$$

f_0 : 施加在电容器上电压的基本频率

C_N : 电容量

15、焦耳损耗功率 P_j

当电容器通过有效电流时, 由于串联电阻 R_s 发热而引起的损耗, 其值为: $P_j = I_{\text{rms}}^2 \times R_s$

8. Maximum peak current \hat{I}

Maximum permitted repetitive peak current that can occur during continuous operation. The value is following:

$$\hat{I} = C_N \times (dV/dt)$$

Where dv/dt indicates rate of voltage rise, which means maximum permitted repetitive rate of voltage rise of operational voltage, usually using instead of \hat{I} .

9. Maximum surge current \hat{I}_s

Peak non-repetitive current induced by swiyching or any other disturbance of the system which is allowed for a limited number of times, for durations shorted than basic period.

10. Series resistance R_s

Effective ohmic resistance of the conductors of a capacitor under specified operating conditions. It depends on temperature and the approximate TCR is $0.004/^\circ\text{C}$. The approximate formula is following,

$$R_s(T_2) = 1 + 0.004 \times (T_2 - T_1) \times R_s(T_1)$$

11. Equivalent series resistance ESR

Effective resistance which, if connected in series with an ideal capacitor of capacitance value equal to that of the capacitor in question, would have a power loss equal to active power dissipated in that capacitor under specified operating conditions.

12. Dielectric dissipation factor $\text{tg } \delta$

Constant dissipation factor of thr dielectric material for all capacitors at their rated frequency. The typical loss factor of polypropylene film is 2×10^{-4} .

13. Loss factor of the capacitor $\text{tg } \delta$

The dissipation factor is ratio between reactive power of the impedance of the capacitor and effective power when capacitor is submitted to a sinusoidal voltage of specified frequency, it is that ratio between the equivalent series resistance and the capacitive reactance of a capacitor.

14. Dielectric power loss P_d

Loss power induced by dielectric polarization or dielectric conductance. The value is following:

$$P_d = \hat{U}^2 \times \pi \times f_0 \times C_N \times \text{tg } \delta$$

Where, for DC capacitors: $\hat{U} = U_r/2$

for AC capacitors: $\hat{U} = \sqrt{2} U_{\text{rms}}$

for GTO snubber capacitors: $\hat{U} = \sqrt{2} U_{\text{NDC}}/2$

f_0 : fundamental frequency

C_N : capacitance

15. Joule power loss P_j

Loss power induced by series resistance of the capacitor under rms current. The value is following:

$$P_j = I_{\text{rms}}^2 \times R_s$$

16、电容器的损耗功率 P_t

电容器所消耗的有功功率，由介质损耗与焦耳损耗组成，
 即 $P_t = P_d + P_j = I_{rms}^2 \times ESR$ 。

17、最大损耗功率 P_{max}

在最高运行温度下电容器可以承载的最大损耗功率。

18、自感 L_s

电容器由于自身结构或组成的原因所表现出来的电感。

19、谐振频率 f_r

电容器的阻抗成为最小时的最低频率。其值为：

$$f_r = 1 / (2 \pi \times \sqrt{L_s \times C_N})$$

20、额定频率 f_N

设计电容器时所规定的频率。

21、运行温度 θ_{case}

在电容器达到热平衡状态时的外壳最热点温度。

22、最高运行温度 θ_{max}

电容器可以运行的最高外壳温度。

23、最低运行温度 θ_{min}

电容器可以运行的最低电介质温度。

24、冷却空气温度 θ_{amb}

在稳定状态条件下，在电容器组最热区域的两单元之间中途所测得的空气温度。

如果仅涉及一单元。则指在离电容器外壳10cm且距其基底2/3高度处所测得的空气温度。

25、外壳温升 $\Delta \theta_{case}$

外壳最热点温度和冷却空气温度之差。

26、热阻 R_{th}

热阻表征的是电容器的发热功率每上升1瓦，电容器内最热点的温度在环境温度 θ_{amb} 的基础上升高的度数。

R_{th} 由内部热点到外壳的热阻 R_{thhc} 与外壳到环境的热阻 R_{thca} 两部分组成。

27、热点温度 θ_{hs}

电容器内部最热点处的温度。其值为： $\theta_{hs} = \theta_{amb} + P_t \times R_{th}$

或者 $\theta_{hs} = \theta_{case} + P_t \times R_{thhc}$

16. Capacitor losses P_t

Active power dissipated in the capacitor, consists of dielectric loss and joule loss., i.e. $P_t = P_d + P_j = I_{rms}^2 \times ESR$.

17. Maximum power loss P_{max}

Maximum power loss at which the capacitor may be operated at the maximum case temperature.

18. Self-inductance L_s

Represents the sum of all inductive elements which are-for mechanical and construction reasons-contained in any capacitor.

19. Resonance frequency f_r

Lowest frequency at which the impedance of the capacitor becomes minimum. The value is following: $f_r = 1 / (2 \pi \times \sqrt{L_s \times C_N})$

20. Rated frequency f_N

Specified frequency for which the capacitor has been designed

21. Operating temperature θ_{case}

Temperature of the hottest point on the case of the operating capacitor in thermal equilibrium.

22. Maximum operating temperature θ_{max}

Highest temperature of the case at which the capacitor may be operated.

23. Lowest operating temperature θ_{min}

Lowest temperature of the dielectric at which the capacitor may be energized.

24. Cooling-air temperature θ_{amb}

Temperature of the air measured at the hottest position of the capacitor, under steady-state conditions, midway between two units.

If only one unit is involved, it is the temperature of surrounding air, measured 10cm away and at 2/3 of the case height of the capacitor under steady-state conditions.

25. Contained temperature rise $\Delta \theta_{case}$

Difference between the temperature of the hottest point of the container and the temperature of the cooling air.

26. Thermal resistance R_{th}

The thermal resistance indicates by how many degrees the capacitor temperature at the hotspot rises above θ_{amb} per watt of the heat dissipation losse.

R_{th} consists of R_{thhc} (thermal resistance from internal hotspot to case) and R_{thca} (thermal resistance from case to ambient).

27. Hotspot temperature θ_{hs}

Temperature at the hottest spot inside the capacitor. The value is following: $\theta_{hs} = \theta_{amb} + P_t \times R_{th}$

OR $\theta_{hs} = \theta_{case} + P_t \times R_{thhc}$

28、容量温度系数 α

电容器在规定的温度范围内容量随温度的变化率。通常以20°C时电容量为参考，用百万分之一每摄氏度 ($10^{-6}/^{\circ}\text{C}$) 表示。
 ($10^{-6}/^{\circ}\text{C} = 1\text{ppm}/^{\circ}\text{C}$)

$$\alpha_i = \frac{C_i - C_o}{C_o(T_i - T_o)}$$

C_i : 电容器在温度 T_i 时容量

C_o : 电容器在 $T_o(20 \pm 2)^{\circ}\text{C}$ 时的容量

29、气候类别

电容器所属的气候类别用斜线分隔的三个数来表示 (IEC 60068-1: 如: 40/85/56)。

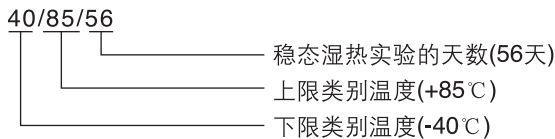

30、绝缘电阻 (IR) / 时间常数 (t)

绝缘电阻为电容器充电一分钟时所加的直流电压和流经电容器的漏电流值的比值，单位为 $M\Omega$ 。时间常数为绝缘电阻和电容量的乘积，通常以秒表示，公式如下: $t[s] = IR [M\Omega] \times C_N[\mu F]$
 一般情况下，绝缘电阻用于描述小容量电容器的绝缘特性，时间常数用于描述大容量(如: $C_N > 0.33\mu F$) 电容器的绝缘特性。

31、自愈性(仅对金属化膜电容器)

电容器的电特性在发生局部电介质击穿后迅速而基本地恢复到击穿前的值的过程。

金属化膜的金属镀层是通过真空蒸发的方法将金属沉积在薄膜上，厚度只有几十个纳米，当介质上存在弱点、杂质时，局部电击穿就可能发生，电击穿处的电弧放电所产生的能量足以使电击穿点邻近处的金属镀层蒸发，使击穿点与周围极板隔开，电容器电气性能即可恢复正常。

32、失效率 λ

表示元件在单位时间内发生失效的概率，数值上等于单位时间内失效的元件数与元件总数的比值。其单位为FIT(也写成Fit或fit)， $1\text{FIT} = 1/(10^9\text{小时})$ 。

举例: 1 0000只元件在给定条件下工作1 0000小时出现了10只失效，则 $\lambda = 10/(1\ 0000 \times 1\ 0000) = 100\ \text{FIT}$ 。

28. Temperature coefficient of capacitance α

The change rate of capacitance with temperature measured over a specified range of temperature. It is normally expressed in parts per million per Celsius degree ($10^{-6}/^{\circ}\text{C}$) and referred to 20°C .

$$\alpha_i = \frac{C_i - C_o}{C_o(T_i - T_o)}$$

C_i : Capacitance at temperature T_i .

C_o : Capacitance at temperature $T_o(20 \pm 2)^{\circ}\text{C}$.

29. Climatic category

The climatic category which the capacitor belongs to is expressed in three numbers separated by slashes, (IEC 60068-1: example 40/85/56).

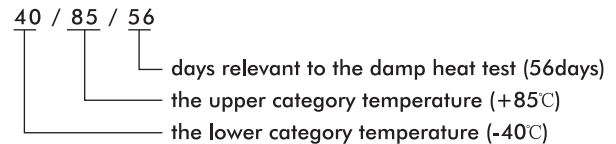

30. Insulation Resistance (IR) / Time Constant (t)

The insulation resistance is the ratio between an applied D.C. voltage and the resulting leakage current after a minute of charge. It is expressed in $M\Omega$. The time constant is expressed in seconds with the following formula: $t[s] = IR [M\Omega] \times C_N[\mu F]$
 In general, Insulation resistance is used for describing smaller capacitance capacitors' insulation character, Time Constant for describing larger ones' (example: $C_N > 0.33\mu F$).

31. Self-healing (Only for metallized film capacitor)

Process by which the electrical properties of the capacitor, after a local breakdown of the dielectric, are rapidly and essentially restored to the values before the breakdown.

The metal coatings of the metallized film, which are vacuum-deposited directly onto the plastic film, have a thickness of only several tens nm. At weak points or impurities in the dielectric, a dielectric breakdown would occur. The energy released by the arc discharge in the breakdown channel is sufficient to totally evaporate the thin metal coating in the vicinity of the channel. The insulated region thus resulting around the former faulty area will cause the capacitor to regain its full operation ability.

32. Failure rate λ

It indicates the failure probability of components in unit time and the value is the number of failure components in unit time compared to the total number of components. The unit of λ is FIT (also expressed as Fit or fit) and $1\ \text{FIT} = 1/(10^9\ \text{hrs})$.

For example, 1 0000 pcs of components work at given conditions for 1 0000 hrs and 10 pcs of components failed, so $\lambda = 10/(1\ 0000 \times 1\ 0000) = 100\ \text{FIT}$.

四、电容器的预期寿命

电容器的预期寿命与电容器的运行电压及热点温度有关。对于应用在不同场合的电容器，它们的设计寿命是不同的。一般而言，应用在直流滤波电路中电容器，在额定电压及热点温度为70℃的应用条件下，它们的预期寿命可达到100 000小时。

电容器的预期寿命是一个基于实践经验和理论计算的统计学数值。以下图片是电容器的预期寿命与运行电压及热点温度之间的特性曲线，仅仅作作为理论参考。对于工作条件与额定条件有差别的情况，可以联系我们的技术部门。

四、Expected lifetime of the capacitor

The expected lifetime of the capacitor depends on the applied voltage and the hot spot temperature during operation. For capacitors applied in different situation, the designed average service lives are different. Generally speaking, capacitors used in DC-Link circuits will have a expected lifetime of probable 100 000 hrs at rated voltage and 70℃ hot spot temperature.

Expected lifetime is a statistical value calculated on the basis of experience and on theoretical evaluations. The following diagrams show the correlation between expected life, operating voltage and hot spot temperature. The diagrams should be considered only as a theoretical reference. Please consult our technical department in case of working condition different from the rated ones.

Expected life VS voltage

(The diagrams should be considered only as a theoretical reference)

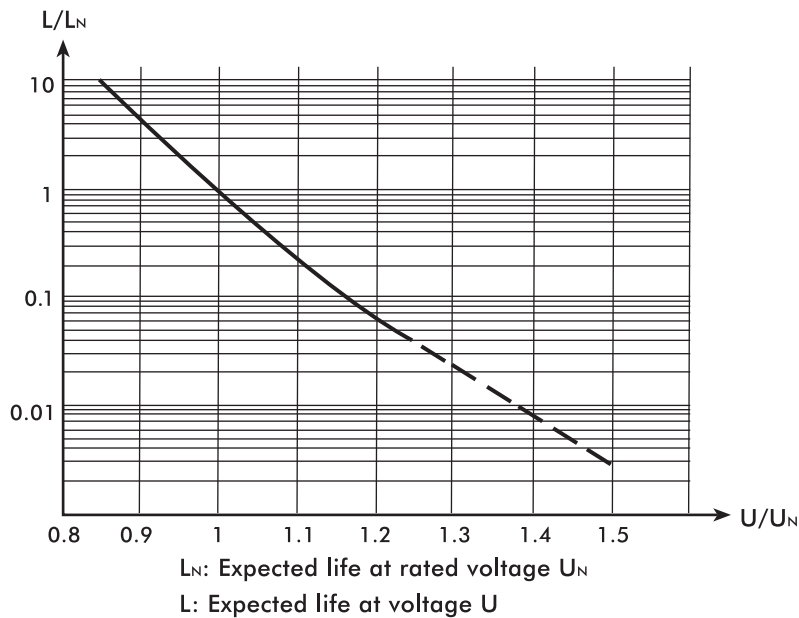

Expected life VS hot spot temperature at U_N

(The diagrams should be considered only as a theoretical reference)

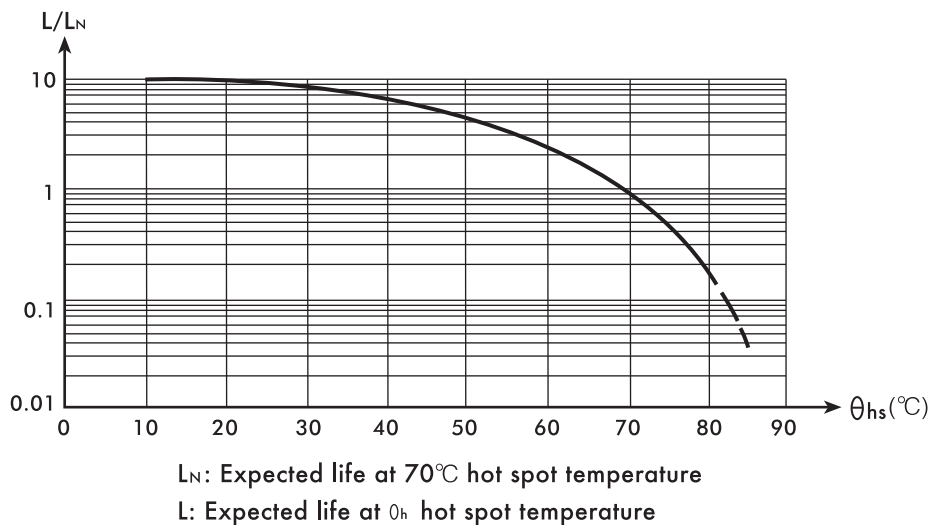

五、使用薄膜电容器的注意事项:

1、工作电压

薄膜电容器的选用取决于施加的最高电压，并受施加的电压波形、电流波形、频率、环境温度(电容器表面温度)、电容量等因素的影响。使用前请先检查电容器两端的电压波形、电流波形和频率(在高频场合，允许电压随着电容器类型的不同而改变，详细资料请参阅说明书)是否在额定值内。

2、工作电流

通过电容器的脉冲(或交流)电流等于电容量C与电压上升速率的乘积，即 $I=C \times dV/dt$ 。

由于电容器存在损耗，在高频或高脉冲条件下使用时，通过电容器的脉冲(或交流)电流会使电容器自身发热而有温升，将会有热击穿(冒烟、起火)的危险。因此，电容器安全使用条件不仅受额定电压(或类别电压)的限制，而且受额定电流的限制。

工作电流被认为是由击穿模式决定的脉冲电流(峰值电流，即由 dV/dt 指标所限制的)和连续电流(以峰峰值或有效值表示)组成，当使用时，需确认这两个电流都在允许范围之内。

3、各种波形的有效值换算关系

不同的波形有效值按下面的公式计算。

五、Caution items in using plastic film capacitors

1. Operation voltage

The plastic film capacitor varies in the maximum applicable voltage depending on the applied voltage waveform, current waveform, frequency, ambient temperature (capacitor surface temperature), capacitance value, etc. Be sure to use capacitors within the specified values by checking the voltage waveform, current waveform, and frequency applied to them (In the application of high frequency, the permissible voltage varies with the type of the capacitor. For detail see the specification).

2. Operating Current

The pulse (or AC) current flowing through the capacitor is expressed as: $I=C \times dV/dt$.

Due to the fact that dissipation factor of the capacitor will generate the internal heat under the application of high frequency or high pulse current, temperature rise in it will occur and may cause deterioration of with standing voltage, even lead to break down (smoking or firing).Therefore, the safety use of capacitor must be within the rated voltage(or category voltage)and the permissible current.

The operating current must be considered by dividing into pulse current(peak current)and continuous current (rms current) depending on the break down mode, and when using, should make sure the both currents are within the permissible values.

3. Calculation of rms in various waveforms

In each waveform, calculate the rms value in the following formula.

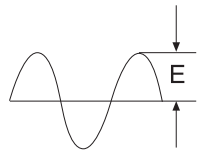
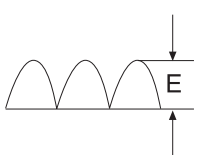
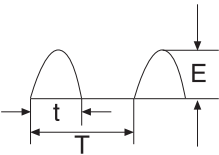
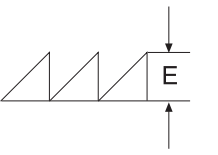
种类(type)	1	2	3	4
波形 (waveform)				
有效值(rms)	$E/\sqrt{2}$	$E/\sqrt{2}$	$E\sqrt{t/(2T)}$	$E/\sqrt{3}$

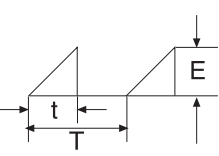
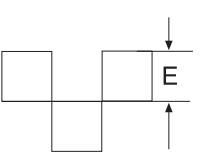
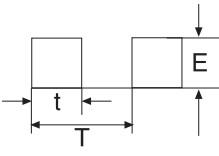
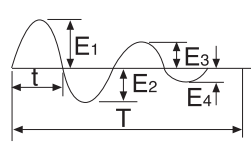
种类(type)	5	6	7	8
波形 (waveform)				
有效值(rms)	$E \sqrt{t/(3T)}$	E	$E \sqrt{t/T}$	$\sqrt{\frac{1}{2T}(E_1^2+E_2^2+E_3^2+E_4^2)}$



4、电容器充放电

由于电容器充放电电流取决于电容量和电压上升速率的乘积，即使是低电压充放电，也可能产生大的瞬间充放电电流，这可能会导致电容器性能的损害，比如说短路或开路。当进行充放电时，请串联一个 $20\Omega/V\sim 1000\Omega/V$ 或更高的限流电阻，将充放电电流限制在规定的范围内。

当多个薄膜电容器并联进行耐电压测试或寿命测试时，请为每个电容器串联一个 $20\Omega/V\sim 1000\Omega/V$ 或更高的限流电阻。详见电容器标准。

另外，在用手操作电容器之前必须对电容器进行充分放电，否则电容器内部残存的能量可能会对操作人员产生致命的伤害。

5、因薄膜振动产生的嗡鸣声

电容器的嗡鸣声是由于电容器薄膜受到两电极间库仑力的作用，产生的振动而发出的声音。施加的电压和频率波形失真越严重，所产生的嗡鸣声越大。但这种嗡鸣声对电容器不会产生任何破坏作用。

6、外壳温升($\Delta \theta_{case}$)

当电容器中通过持续电流时，热量累积会使电容器内部温度升高。当温度超出允许的热点温度时，可能会导致电容器短路甚至燃烧。因此，流经电容器的电流不允许超过产品目录所规定的最大数值，而且有必要监测电容器加载时的温升。

7、阻燃性

尽管在薄膜电容器外封装中使用了耐火性阻燃材料—阻燃环氧树脂或塑壳，但外部的持续高温或火焰仍可使电容器芯子变形而产生外封装破裂，导致电容器芯子融化或燃烧。

4. Charging and discharging

Because the charging and discharging current of capacitor is obtained by the product of voltage rise rate(dv/dt)and capacitance, low voltage charging and discharging may also cause deterioration of capacitor such as shorting and open due to sudden charging and discharging current. When charging and discharging, pass through a resistance of $20\Omega/V$ to $1000\Omega/V$ or more to limit current.

When connecting multiple film capacitors in parallel in withstand voltage test or life test, connect a resistance of $20\Omega/V$ to $1000\Omega/V$ or more in series to each capacitor.(For detail see the specification)

In additional, capacitors must be discharged with resistor before handling. Because the capacitor hasn't discharge resistor inside, so there is residual but maybe deathful electric energy contained.

5. Buzzing noise

Any buzzing noise produced by capacitor is caused by the vibration of the film due to the coulomb force that is generated between the electrodes with opposite poles.If the wave-form with a high distortion rate or frequency is applied accross the capacitor,the buzzing noise will become louder.But the buzzing noise is of no damage to capacitor.

6. Contained temperature rise ($\Delta \theta_{case}$)

When continuing current flows through the capacitor, the temperature inside the capacitor will rise, induced by accumulated heat. If the temperature exceeds allowed hot-spot temperature, it might cause a short circuit or fire. The limits described in the catalogue are not exceeded and it's necessary to check the temperature on the capacitor surface when it works.

7. Flame retardation

Although flame retardation epoxy resin or plastic case is used in the coating or encapsulating of plastic film capacitor, continuous outer high temperature or firing will break the coating layer or plastic case of the capacitor ,and may lead to melting and firing of the capacitor element.

有陷燃烧等级 (Category of flammability)	针对电容器体积范围(mm^3) 施加火焰时间(s)				最大燃烧时间 (s)
	体积 ≤ 250	$250 < \text{体积} \leq 500$	$500 < \text{体积} \leq 1750$	$1750 < \text{体积}$	
A	15	30	60	120	3
B	10	20	30	60	10
C	5	10	20	30	30

8、高湿环境

如果长时间使用在高湿环境下，电容器可能会吸收潮气、电

8. Humid ambient.

If used for a long time in a humid ambient,the capacitor might



极被氧化，导致电容器损坏。如果是在AC条件下使用，高湿环境将会加剧电晕的影响，从而引起电容量下降、损耗增加。

9、贮存条件

1、电容器不能贮存在腐蚀性的空气环境中，特别是存在氢化物、硫化物、酸、碱、盐、有机溶剂或类似物质时。

2、产品不能暴露在高温和高湿状态，必须保存在以下环境中：（在不拆开原包装的基础上）

温度：不超过35°C

湿度：不超过80% RH，不允许有冷露

贮存时间：不超过24个月（从产品包装或产品本体上的日期算起）

六、绿色产品

RoHS符合性

在此产品目录中的，法拉公司的产品均符合RoHS指令和《电子信息产品污染控制管理办法》的要求。

七、客户订购指南

请尽量提供以下信息：

- 1、应用场合：如UPS、变频器、整流器等
- 2、额定电容量及允许偏差
- 3、电压：包括额定电压、工作电压、纹波电压、非周期冲击电压等
- 4、电流：包括最大电流、工作电流、最大峰值电流、最大冲击电流等
- 5、频率：包括工作频率，脉冲频率，纹波电压的频率等
- 6、工作场所：如固定场所、车辆、船舶等
- 7、工作环境：如温度范围、湿度、海拔、散热方式等
- 8、产品尺寸：如直径、高度或长度、宽度、高度等
- 9、端子类型：如螺栓式、螺孔式、接线片、插片式等
- 10、安全要求：如阻燃、防爆等
- 11、预期寿命：在给定的工作条件下的预期寿命
- 12、安装方式：如底部螺栓、中部卡圈、安装耳等
- 13、其它

absorb humidity and oxidise the electrodes causing breakage of the capacitor.If case of AC application,high humidity would increase the corona effect.This phenomenon causes a drop of capacitance and a increase of capacitor losses.

9. Storage conditions:

1. Capacitors may not be stored in corrosive atmospheres, particularly not when chlorides, sulfides, acids, lye, salts, organic solvents or similar substances are present.

2. It shouldn't be located in particularly high temperature and high humidity, it must submit to the following conditions (unchanging primal package):

Temperature: $\leq 35^{\circ}\text{C}$

Humidity: $\leq 80\% \text{ RH}$, no dew allowed on the capacitor.

Storage time: ≤ 24 months(from the date marked on the capacitor's body or the label glued to the package)

六、Green Products

RoHS Compliance

Faratronic products in the catalogue are RoHS Compliant.

七、Guide for customer ordering

Please provide following information as possible as you can

1. Application: for example, UPS, transducer, rectifier etc.
2. Rated capacitance and tolerance
3. Voltage: including rated voltage, working voltage, ripple voltage, non-recurrent surge voltage
4. Current: including maximum current, working current, maximum peak current, maximum surge current etc.
5. Frequency: including working frequency, pulse frequency, frequency of ripple voltage etc.
6. Working location: for example, fixed-location, vehicle, watercraft etc.
7. Working environment: for example, temperature range, humidity, altitude, cooling mode etc.
8. Dimensions: for example, diameter, height or length, width, height etc.
9. Terminal form: for example, stud, thread hole, lug, tab, etc.
10. Safety: for example, flame resistance, anti-explosion etc.
11. Expected lifetime: under given working conditions.
12. Fixed style: for example, bottom-stud, middle-clip, mounting ears etc.
13. Others

八、产品编码说明 Part number system

■ 18位产品代码如下:

The 18 digits part number is formed as follow:

1	2	3	4	5	6	7	8	9	10	11	12	13	14	15	16	17	18
C																	

第1~3位	型号代码	Digit 1 to 3	Series code
第4~5位	额定电压(参见table 1)	Digit 4 to 5	Rated voltage(refer to table 1)
第6~8位	标称容量(按照JIS标准)	Digit 6 to 8	Rated capacitance value (JIS Standard)
	107=10 × 10 ⁷ pF=100μF		107=10 × 10 ⁷ pF=100μF
第9位	容量偏差	Digit 9	Capacitance tolerance
	G= ± 2%, H= ± 3%, J= ± 5%		G= ± 2%,H= ± 3%,J= ± 5%
	K= ± 10%, N=0~10%		K= ± 10%,N=0~10%
第10位	引线脚距(参见table 2)	Digit 10	Pitch(refer to table 2)
	(适用于C3D,C3H,C6A系列)		(for C3D,C3H,C6A series)
第10位	外形尺寸代码	Digit 10	Dimension code
	(适用于C38, C3A,C3B,C3G, C3K,C65(A),C66		(forC38, C3A,C3B,C3G, C3K, C65(A),C66,
	C67,C69等系列, 参照各个系列的说明)		C67,C69 related to each series)
第11位	内部特征码	Digit 11	Internal use
第12~15位	引出端代码	Digit 12 to 15	Terminals code
	(参照各个系列的说明)		(related to each series)
第16~18位	内部特征码	Digit 16 to 18	Internal use

■ 例如 for example

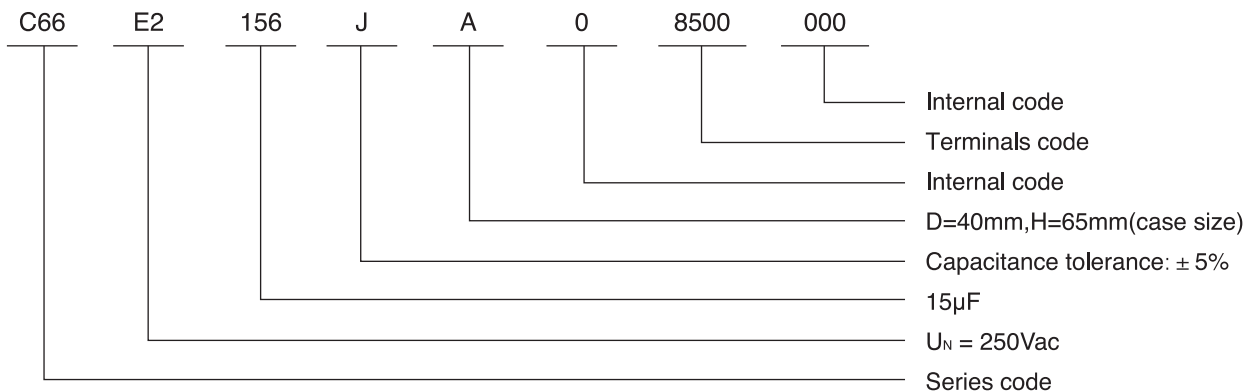



■ Table1 额定电压代码 Rated voltage code

	A	B	C	D	E	F	G	H	J	K	L	M	N
1			16	20	25			50	63	80	132	1 100	2 400
2	100	125	160	200	250	315	400	500	630	800	120	1 300	2 200
3	1 000	1 250	1 600	2 000	2 500	3 150	4 000	5 000	6 300	8 000	1 200	1 400	2 600
4											180	1 500	
5											150	1 900	
6												1 800	
7												1 700	

	P	Q	R	S	T	U	V	W	X	Y			
1	240	300	330	440	540	600	700	850	900				
2	275	305	350	450	520	690	760	875					
3	280	310	320	480	550	660	750						
4	220	3 000	345	430	560	620	7 000						
5	230	3 050	3 500	460	5 500	650	7 500						
6	2 800	3 200	375	4 500	525	6 000	780						
7	2 250	3 300		410	580	6 500							
8						680							

说明：参考日本JIS标准，字母加数字表示交流，数字加字母表示直流，例如A2表示100Vac，2A表示100Vdc

Exaplmention: Refer to JIS standard, Letter and then number indicate AC, but number and then Letter indicate DC,
 for example, 2A indicate 100Vdc, A2 indicate 100Vac.

■ Table2 脚距代码 Pict code

Code	0	2	3	4	5	6	8	9	A	B
Pitch	axial	5.0	7.5	10	12.5	15	20	22.5	25.0	27.5
Code	C	D	F	H	M	R				
Pitch	30	32.5	37.5	42.5	52.5	62.5				